

(1/3 M)

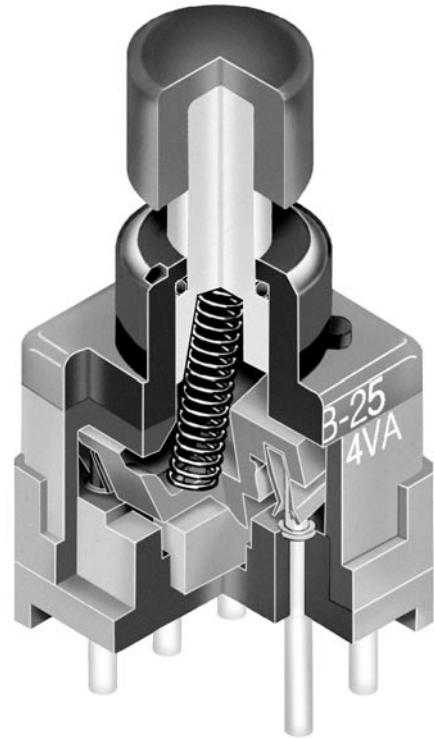

STC

(" ; " " ")

6

0.100" x 0.100" (2.54 x 2.54)

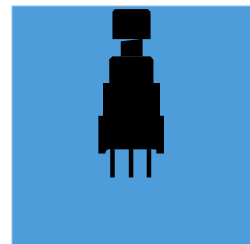

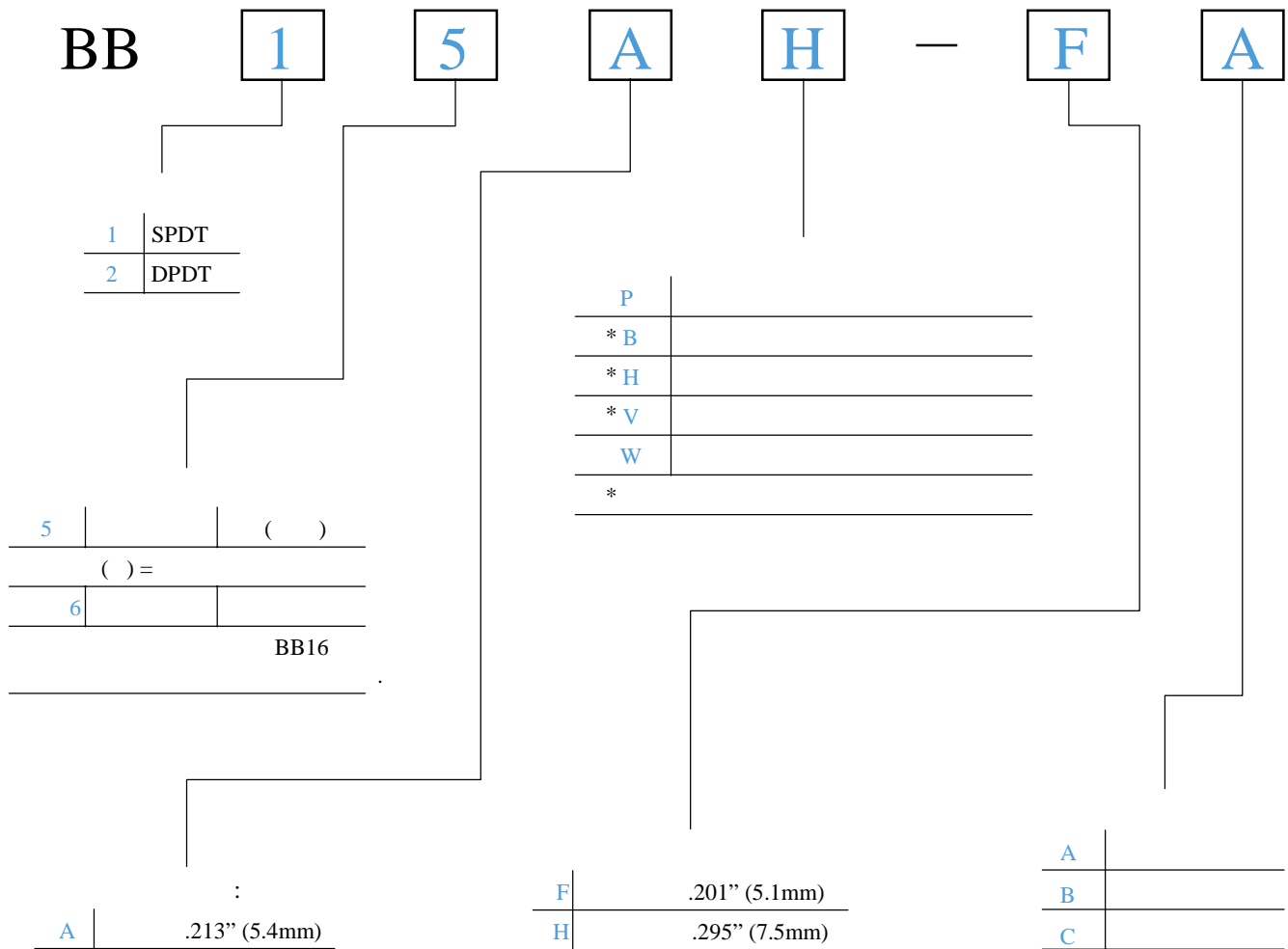

BB15AH-FA

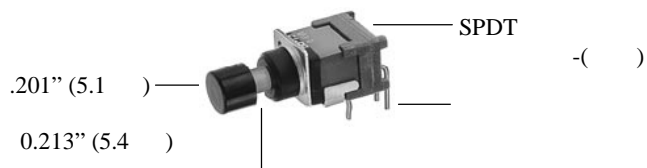

		() =				
SP	BB15 BB16		()	2-3	2-1	SPDT
DP	BB25 BB26		()	2-3 5-6	2-1 5-4	DPDT

A

.213" (5.4)

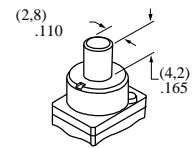
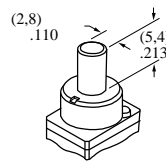

P

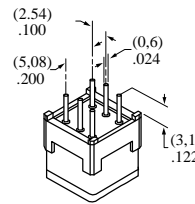

B

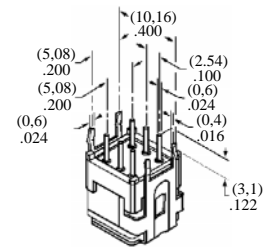

H

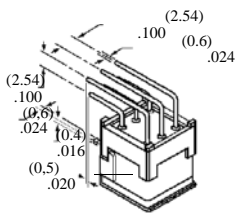

V

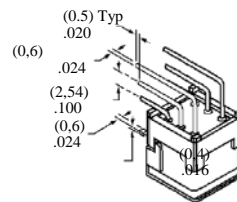

W

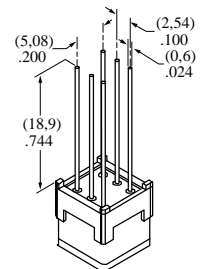

I

.201" (5.1)

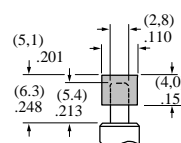

J

.295" (7.5)

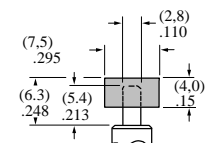

A

B

C

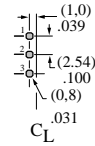
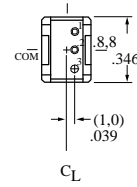
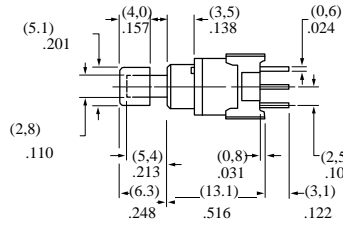
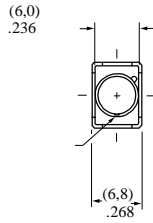

BB15AP-FA

BB16AP

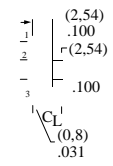
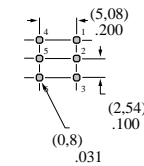
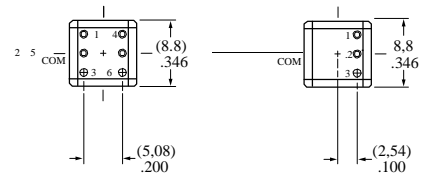
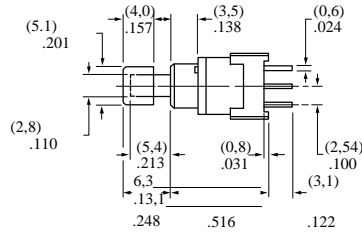
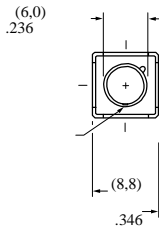

BB25AP-FA

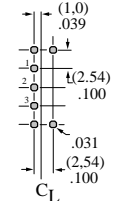
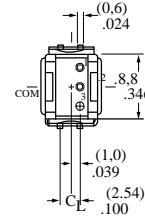
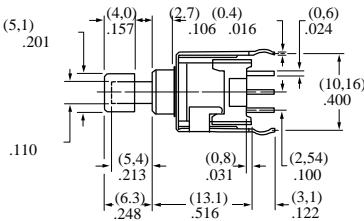
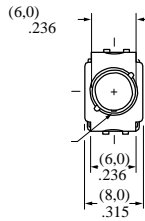

BB15AB-FA

BB16AB

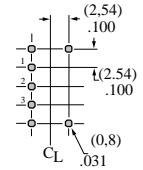
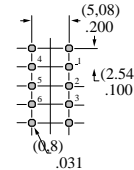
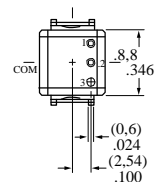
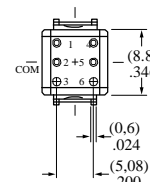
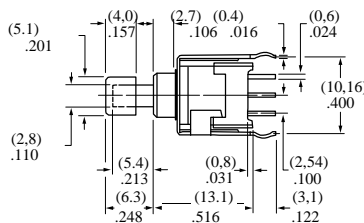
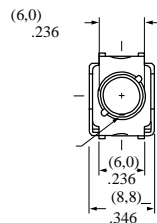

BB25AB-FA

C



BB15AH-FA

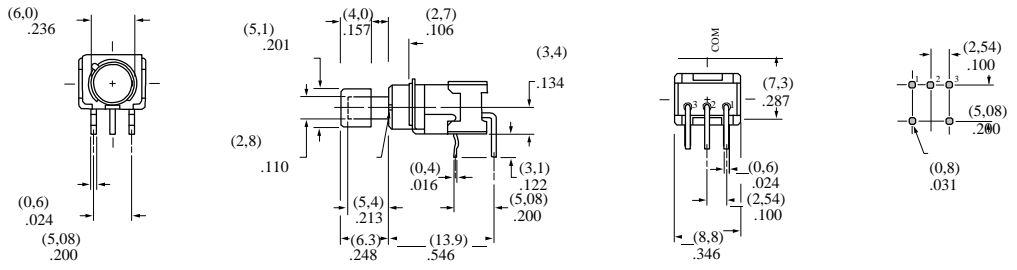

BB16AH



BB25AH-FA

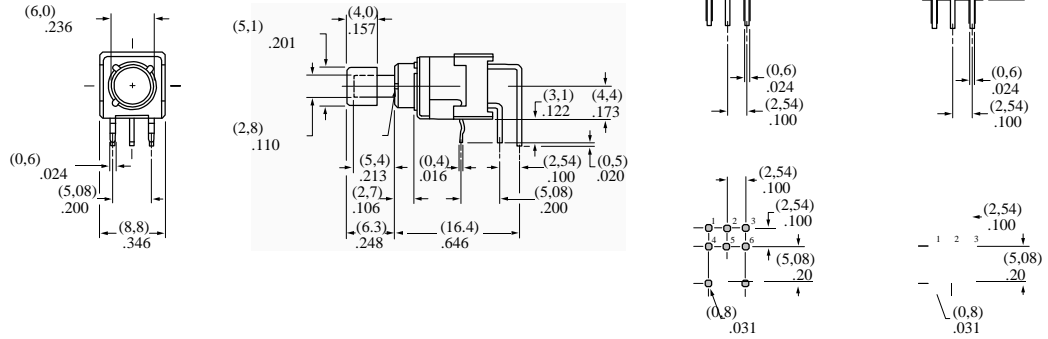

BB15AV-FA

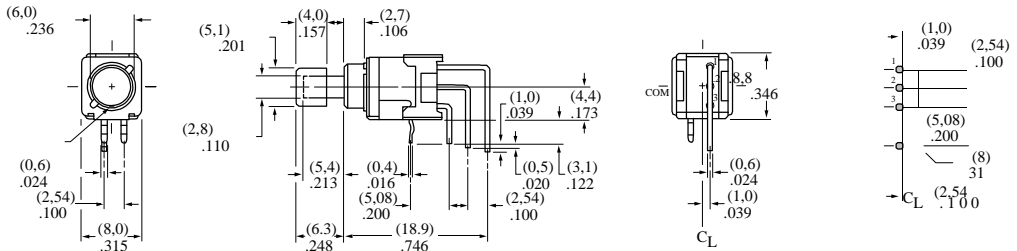

BB16AV



BB25AV-FA

